

MULTILAYER CERAMIC CAPACITORS

Features

- * Wide capacitance range, extremely compact size.
- * Low inductance of capacitor for high frequency application.
- * Excellent solderability and resistance to soldering heat, suitable for flow and reflow soldering.
- * Adaptable to high speed surface mount assembly.
- * Conform to EIAJ-RC3402, and also compatible with EIA-RS198 and IEC PUB. 384-10

Part Number System

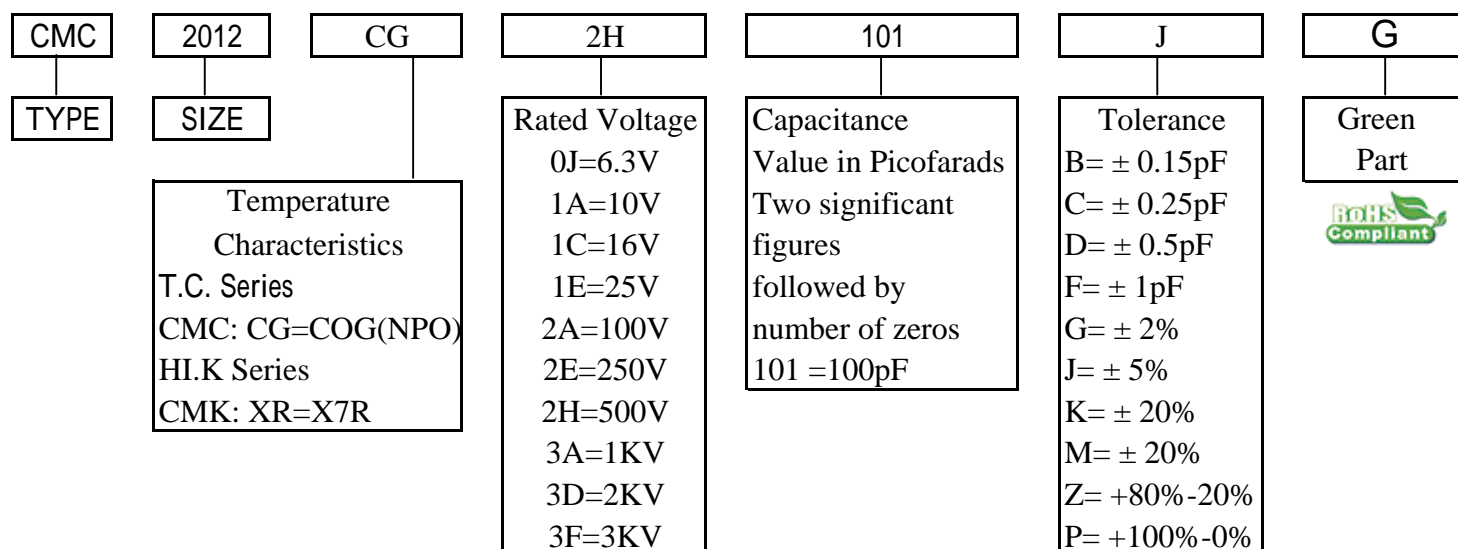

Dimensions mm(inches)

Size Code	L	W	T(Max)	S(Min)
1608 (0603)	1.60 (0.06)	0.80 (0.03)	0.80 (0.03)	0.20 (0.008)
2012 (0805)	2.00 (0.08)	1.25 (0.05)	1.20 (0.05)	0.50 (0.02)
3216 (1206)	3.20 (0.125)	1.60 (0.06)	1.80 (0.07)	0.50 (0.02)
3225 (1210)	3.20 (0.125)	2.50 (0.1)	2.20 (0.09)	0.50 (0.02)
4520 (1808)	4.50 (0.18)	2.00 (0.08)	2.20 (0.09)	0.50 (0.02)
4532 (1812)	4.50 (0.18)	3.20 (0.12)	2.20 (0.09)	0.50 (0.02)
5628 (2211)	5.60 (0.22)	2.80 (0.11)	2.20 (0.09)	0.50 (0.02)

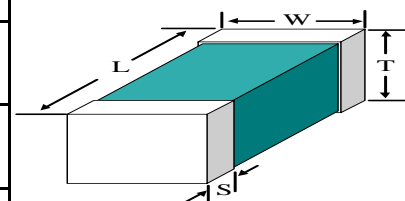

DIELECTRIC CHARACTERISTICS

CMC Series - COG (NPO) Type

Operating Temperature Range : -55 ~ 125
 Temperature Coefficient : $0 \pm 30 \text{ppm} /$
 Dissipation Factor : 0.001(0.1%) max. @25
 Insulation Resistance 25 : $>100\text{G}$ or > 1000 F
 125 : $>10\text{G}$ or > 100 F
 Dielectric Withstanding Voltage : Rated Voltage
 less than 1KV DC 150% of the rated voltage
 more than 1KV DC 120% of the rated voltage
 Aging Rate : 0% per decade hour
 Test Parameters : 1MHz for 1000pF, 1KHz for $> 1000\text{pF}$,
 1 $\pm 0.2\text{Vrms}$ at 25

Typical Performance Curves#

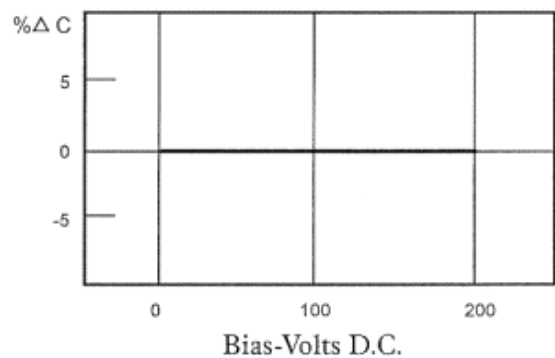
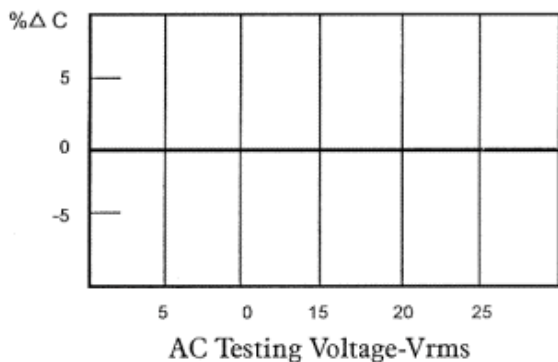
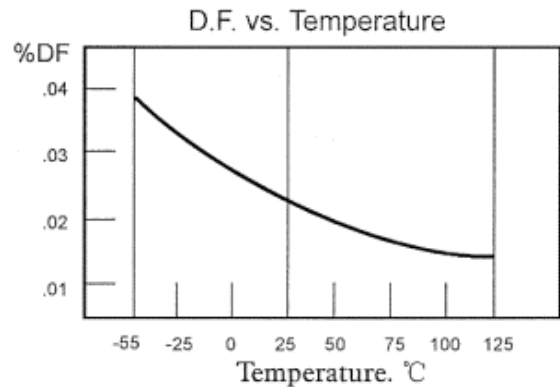
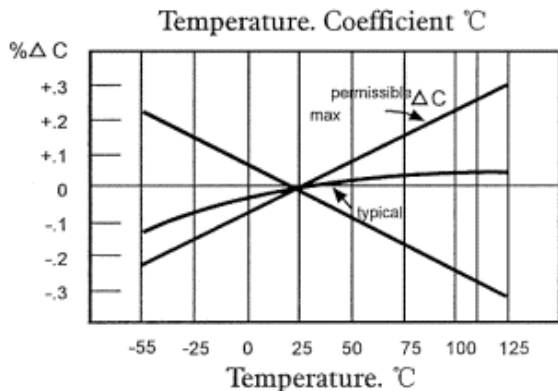

CMC Series (COG)					
Capacitance Range					
Size	1608	2012	3216	4250	4532
Voltage	(0603)	(0805)	(1206)	(1808)	(1812)
Min. Capacitance ~ Max. Capacitance					
100V	10 ~ 102	102 ~ 222	102 ~ 472	---	102 ~ 223
250V	10 ~ 471	10 ~ 102	222 ~ 472	---	102 ~ 103
500V	---	10 ~ 471	101 ~ 222	---	102 ~ 472
1KV	---	10 ~ 221	10 ~ 102	---	101 ~ 472
2KV	---	---	10 ~ 221	101 ~ 221	101 ~ 102
3KV	---	---	---	2 ~ 151	101 ~ 471

DIELECTRIC CHARACTERISTICS

CMK Series - X7R Type

Operating Temperature Range -55 ~ 125

Temperature Coefficient : C±15% Max

Dissipation Factor : 0.025(2.5%) Max. @25

Insulation Resistance 25 >100GΩ or > 1000Ω F
 125 : >10GΩ or > 100Ω F

Dielectric Withstanding Vo Rated Voltage

less than 1KV DC

150% of the rated voltage

more than 1KV DC

120% of the rated voltage

Aging Rate : 2.0% per decade hour

Test Parameters : 1KHz, 1.0±0.2Vrms at 25

Typical Performance Curves#

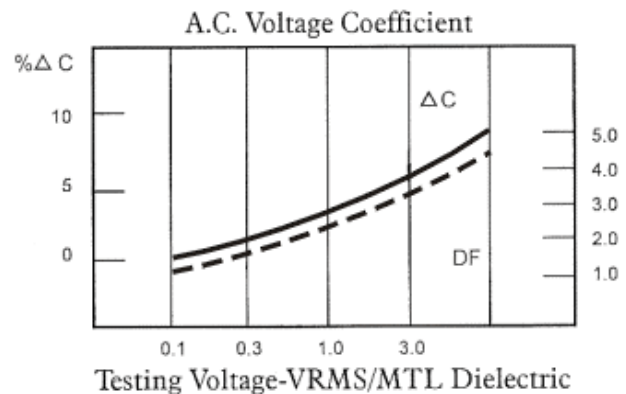
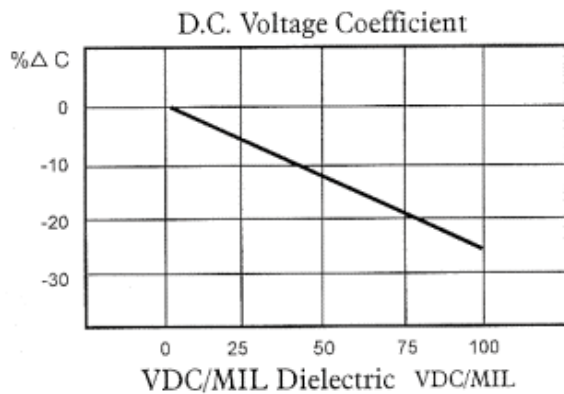
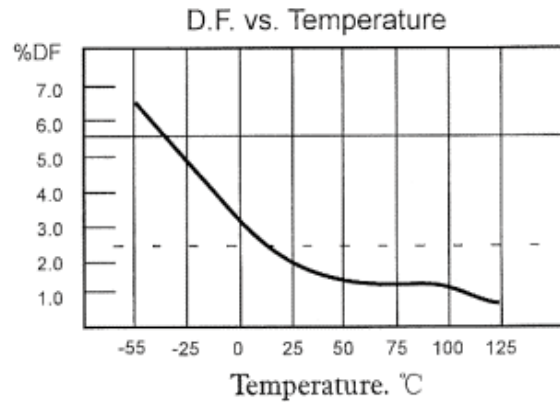
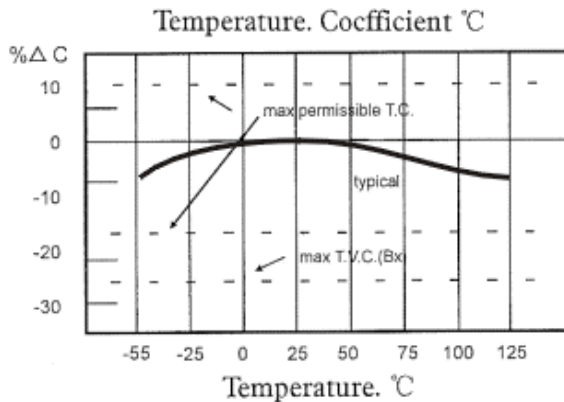

CMC Series (X7R)							
Capacitance Range							
Size	1608	2012	3216	3225	4250	4532	5628
Voltage	(0603)	(0805)	(1206)	(1210)	(1808)	(1812)	(2211)
Min. Capacitance ~ Max. Capacitance							
100V	221 ~ 103	221 ~ 473	333 ~ 104	104 ~ 474	---	104 ~ 684	---
250V	221 ~ 472	221 ~ 223	103 ~ 473	683 ~ 224	---	473 ~ 334	---
500V	---	221 ~ 472	221 ~ 223	223 ~ 473	---	472 ~ 823	---
1KV	---	221 ~ 152	221 ~ 103	103 ~ 223	221 ~ 183	101 ~ 223	---
2KV	---	---	221 ~ 222	272 ~ 472	221 ~ 332	101 ~ 472	---
3KV	---	---	---	---	221 ~ 102	101 ~ 182	221 ~ 272

MULTILAYER CERAMIC CAPACITORS

MID VOLTAGE CMC 1608 (0603) SERIES

Rated Voltage: 100V

Part No.		Capacitance (PF)	Tolerance	Thickness (mm)
CMC 1608CG 2A100	*	10	D	0.8±0.10
CMC 1608CG 2A120	*	12	J, K	0.8±0.10
CMC 1608CG 2A150	*	15	J, K	0.8±0.10
CMC 1608CG 2A180	*	18	J, K	0.8±0.10
CMC 1608CG 2A220	*	22	J, K	0.8±0.10
CMC 1608CG 2A270	*	27	J, K	0.8±0.10
CMC 1608CG 2A330	*	33	J, K	0.8±0.10
CMC 1608CG 2A390	*	39	J, K	0.8±0.10
CMC 1608CG 2A470	*	47	J, K	0.8±0.10
CMC 1608CG 2A560	*	56	J, K	0.8±0.10
CMC 1608CG 2A680	*	68	J, K	0.8±0.10
CMC 1608CG 2A820	*	82	J, K	0.8±0.10
CMC 1608CG 2A101	*	100	J, K	0.8±0.10
CMC 1608CG 2A121	*	120	J, K	0.8±0.10
CMC 1608CG 2A151	*	150	J, K	0.8±0.10
CMC 1608CG 2A181	*	180	J, K	0.8±0.10
CMC 1608CG 2A221	*	220	J, K	0.8±0.10
CMC 1608CG 2A271	*	270	J, K	0.8±0.10
CMC 1608CG 2A331	*	330	J, K	0.8±0.10
CMC 1608CG 2A391	*	390	J, K	0.8±0.10
CMC 1608CG 2A471	*	470	J, K	0.8±0.10
CMC 1608CG 2A561	*	560	J, K	0.8±0.10
CMC 1608CG 2A681	*	680	J, K	0.8±0.10
CMC 1608CG 2A102	*	1000	J, K	0.8±0.10

Rated Voltage: 250V

CMC 1608CG 2E100	*	10	D	0.8±0.10
CMC 1608CG 2E120	*	12	J, K	0.8±0.10
CMC 1608CG 2E150	*	15	J, K	0.8±0.10
CMC 1608CG 2E180	*	18	J, K	0.8±0.10
CMC 1608CG 2E220	*	22	J, K	0.8±0.10
CMC 1608CG 2E270	*	27	J, K	0.8±0.10
CMC 1608CG 2E330	*	33	J, K	0.8±0.10
CMC 1608CG 2E390	*	39	J, K	0.8±0.10
CMC 1608CG 2E470	*	47	J, K	0.8±0.10
CMC 1608CG 2E560	*	56	J, K	0.8±0.10
CMC 1608CG 2E680	*	68	J, K	0.8±0.10
CMC 1608CG 2E820	*	82	J, K	0.8±0.10
CMC 1608CG 2E101	*	100	J, K	0.8±0.10
CMC 1608CG 2E121	*	120	J, K	0.8±0.10
CMC 1608CG 2E151	*	150	J, K	0.8±0.10
CMC 1608CG 2E181	*	180	J, K	0.8±0.10
CMC 1608CG 2E221	*	220	J, K	0.8±0.10
CMC 1608CG 2E271	*	270	J, K	0.8±0.10
CMC 1608CG 2E331	*	330	J, K	0.8±0.10
CMC 1608CG 2E391	*	390	J, K	0.8±0.10
CMC 1608CG 2E471	*	470	J, K	0.8±0.10

MULTILAYER CERAMIC CAPACITORS

MID VOLTAGE CMC 2012 (0805) SERIES

Rated Voltage: 100V

Part No.		Capacitance (PF)	Tolerance	Thickness (mm)
CMC 2012CG 2A102	*	1000	J, K	1.2±0.15
CMC 2012CG 2A122	*	1200	J, K	1.2±0.15
CMC 2012CG 2A152	*	1500	J, K	1.2±0.15
CMC 2012CG 2A182	*	1800	J, K	1.2±0.15
CMC 2012CG 2A222	*	2200	J, K	1.2±0.15

Rated Voltage: 250V

CMC 2012CG 2E100	*	10	D	0.6±0.10
CMC 2012CG 2E120	*	12	J, K	0.6±0.10
CMC 2012CG 2E150	*	15	J, K	0.6±0.10
CMC 2012CG 2E180	*	18	J, K	0.8±0.10
CMC 2012CG 2E220	*	22	J, K	0.8±0.10
CMC 2012CG 2E270	*	27	J, K	0.8±0.10
CMC 2012CG 2E330	*	33	J, K	0.8±0.10
CMC 2012CG 2E390	*	39	J, K	0.8±0.10
CMC 2012CG 2E470	*	47	J, K	0.8±0.10
CMC 2012CG 2E560	*	56	J, K	0.8±0.10
CMC 2012CG 2E680	*	68	J, K	0.8±0.10
CMC 2012CG 2E820	*	82	J, K	0.8±0.10
CMC 2012CG 2E101	*	100	J, K	0.8±0.10
CMC 2012CG 2E121	*	120	J, K	0.8±0.10
CMC 2012CG 2E151	*	150	J, K	0.8±0.10
CMC 2012CG 2E181	*	180	J, K	0.8±0.10
CMC 2012CG 2E221	*	220	J, K	0.8±0.10
CMC 2012CG 2E271	*	270	J, K	0.8±0.10
CMC 2012CG 2E331	*	330	J, K	0.8±0.10
CMC 2012CG 2E391	*	390	J, K	0.8±0.10
CMC 2012CG 2E471	*	470	J, K	1.0±0.15
CMC 2012CG 2E561	*	560	J, K	1.0±0.15
CMC 2012CG 2E681	*	680	J, K	1.0±0.15
CMC 2012CG 2E821	*	820	J, K	1.2±0.15
CMC 2012CG 2E102	*	1000	J, K	1.2±0.15

MULTILAYER CERAMIC CAPACITORS

MID VOLTAGE CMC 2012 (0805) SERIES**Rated Voltage: 500V**

Part No.		Capacitance (PF)	Tolerance	Thickness (mm)
CMC 2012CG 2H100	*	10	D	0.6±0.10
CMC 2012CG 2H120	*	12	J, K	0.6±0.10
CMC 2012CG 2H150	*	15	J, K	0.6±0.10
CMC 2012CG 2H180	*	18	J, K	0.8±0.10
CMC 2012CG 2H220	*	22	J, K	0.8±0.10
CMC 2012CG 2H270	*	27	J, K	0.8±0.10
CMC 2012CG 2H330	*	33	J, K	0.8±0.10
CMC 2012CG 2H390	*	39	J, K	0.8±0.10
CMC 2012CG 2H470	*	47	J, K	0.8±0.10
CMC 2012CG 2H560	*	56	J, K	0.8±0.10
CMC 2012CG 2H680	*	68	J, K	0.8±0.10
CMC 2012CG 2H820	*	82	J, K	0.8±0.10
CMC 2012CG 2H101	*	100	J, K	0.8±0.10
CMC 2012CG 2H121	*	120	J, K	1.0±0.15
CMC 2012CG 2H151	*	150	J, K	1.0±0.15
CMC 2012CG 2H181	*	180	J, K	1.2±0.15
CMC 2012CG 2H221	*	220	J, K	1.2±0.15
CMC 2012CG 2H271	*	270	J, K	1.2±0.15
CMC 2012CG 2H331	*	330	J, K	1.2±0.15
CMC 2012CG 2H391	*	390	J, K	1.2±0.15
CMC 2012CG 2H471	*	470	J, K	1.2±0.15

Rated Voltage: 1KV

CMC 1608CG 3A100	*	10	D	0.6±0.10
CMC 1608CG 3A120	*	12	J, K	0.6±0.10
CMC 1608CG 3A150	*	15	J, K	0.6±0.10
CMC 1608CG 3A180	*	18	J, K	0.8±0.10
CMC 1608CG 3A220	*	22	J, K	0.8±0.10
CMC 1608CG 3A270	*	27	J, K	0.8±0.10
CMC 1608CG 3A330	*	33	J, K	0.8±0.10
CMC 1608CG 3A390	*	39	J, K	0.8±0.10
CMC 1608CG 3A470	*	47	J, K	0.8±0.10
CMC 1608CG 3A560	*	56	J, K	0.8±0.10
CMC 1608CG 3A680	*	68	J, K	0.8±0.10
CMC 1608CG 3A820	*	82	J, K	0.8±0.10
CMC 1608CG 3A101	*	100	J, K	0.8±0.10
CMC 1608CG 3A121	*	120	J, K	1.0±0.15
CMC 1608CG 3A151	*	150	J, K	1.0±0.15
CMC 1608CG 3A181	*	180	J, K	1.2±0.15
CMC 1608CG 3A221	*	220	J, K	1.2±0.15

MULTILAYER CERAMIC CAPACITORS

MID VOLTAGE CMC 3216 (1206) SERIES

Rated Voltage: 100V

Part No.		Capacitance (PF)	Tolerance	Thickness (mm)
CMC 3216CG 2A102	*	1000	J, K	0.8±0.10
CMC 3216CG 2A222	*	2200	J, K	1.0±0.15
CMC 3216CG 2A272	*	2700	J, K	1.2±0.15
CMC 3216CG 2A332	*	3300	J, K	1.2±0.15
CMC 3216CG 2A392	*	3900	J, K	1.2±0.15
CMC 3216CG 2A472	*	4700	J, K	1.6±0.20

Rated Voltage: 250V

CMC 3216CG 2E222	*	2200	J, K	1.0±0.15
CMC 3216CG 2E272	*	2700	J, K	1.2±0.15
CMC 3216CG 2E332	*	3300	J, K	1.6±0.20
CMC 3216CG 2E392	*	3900	J, K	1.6±0.20
CMC 3216CG 2E472	*	4700	J, K	1.6±0.20

Rated Voltage: 500V

Part No.		Capacitance (PF)	Tolerance	Thickness (mm)
CMC 3216CG 2H101	*	100	J, K	0.8±0.10
CMC 3216CG 2H121	*	120	J, K	0.8±0.10
CMC 3216CG 2H151	*	150	J, K	0.8±0.10
CMC 3216CG 2H181	*	180	J, K	0.8±0.10
CMC 3216CG 2H221	*	220	J, K	0.8±0.10
CMC 3216CG 2H2471	*	270	J, K	0.8±0.10
CMC 3216CG 2H331	*	330	J, K	0.8±0.10
CMC 3216CG 2H391	*	390	J, K	0.8±0.10
CMC 3216CG 2H471	*	470	J, K	0.8±0.10
CMC 3216CG 2H561	*	560	J, K	1.0±0.15
CMC 3216CG 2H681	*	680	J, K	1.2±0.15
CMC 3216CG 2H821	*	820	J, K	0.8±0.1
CMC 3216CG 2H102	*	1000	J, K	1.6±0.20
CMC 3216CG 2H122	*	1200	J, K	1.6±0.20
CMC 3216CG 2H152	*	1500	J, K	1.6±0.20
CMC 3216CG 2H182	*	1800	J, K	1.6±0.20
CMC 3216CG 2H222	*	2200	J, K	1.6±0.20

MULTILAYER CERAMIC CAPACITORS

HIGH VOLTAGE CMC 3216 (1206) SERIES

Rated Voltage: 1KV

Part No.		Capacitance (PF)	Tolerance	Thickness (mm)
CMC 3216CG 3A100	*	10	D	0.8±0.10
CMC 3216CG 3A120	*	12	J, K	0.8±0.10
CMC 3216CG 3A150	*	15	J, K	0.8±0.10
CMC 3216CG 3A180	*	18	J, K	0.8±0.10
CMC 3216CG 3A220	*	22	J, K	0.8±0.10
CMC 3216CG 3A270	*	27	J, K	0.8±0.10
CMC 3216CG 3A330	*	33	J, K	0.8±0.10
CMC 3216CG 3A390	*	39	J, K	0.8±0.10
CMC 3216CG 3A470	*	47	J, K	0.8±0.10
CMC 3216CG 3A560	*	56	J, K	0.8±0.10
CMC 3216CG 3A680	*	68	J, K	0.8±0.10
CMC 3216CG 3A820	*	82	J, K	0.8±0.10
CMC 3216CG 3A101	*	100	J, K	0.8±0.10
CMC 3216CG 3A121	*	120	J, K	0.8±0.10
CMC 3216CG 3A151	*	150	J, K	0.8±0.10
CMC 3216CG 3A181	*	180	J, K	0.8±0.10
CMC 3216CG 3A221	*	220	J, K	0.8±0.10
CMC 3216CG 3A271	*	270	J, K	0.8±0.10
CMC 3216CG 3A331	*	330	J, K	0.8±0.10
CMC 3216CG 3A391	*	390	J, K	0.8±0.10
CMC 3216CG 3A471	*	470	J, K	0.8±0.10
CMC 3216CG 3A561	*	560	J, K	0.8±0.10
CMC 3216CG 3A681	*	680	J, K	1.0±0.15
CMC 3216CG 3A821	*	820	J, K	1.2±0.15
CMC 3216CG 3A102	*	1000	J, K	1.6±0.20

Rated Voltage: 2KV

CMC 3216CG 3D100	*	10	D	1.2±0.15
CMC 3216CG 3D120	*	12	J, K	1.2±0.15
CMC 3216CG 3D150	*	15	J, K	1.2±0.15
CMC 3216CG 3D180	*	18	J, K	1.2±0.15
CMC 3216CG 3D220	*	22	J, K	1.2±0.15
CMC 3216CG 3D270	*	27	J, K	1.2±0.15
CMC 3216CG 3D330	*	33	J, K	1.2±0.15
CMC 3216CG 3D390	*	39	J, K	1.2±0.15
CMC 3216CG 3D470	*	47	J, K	1.2±0.15
CMC 3216CG 3D560	*	56	J, K	1.2±0.15
CMC 3216CG 3D680	*	68	J, K	1.2±0.15
CMC 3216CG 3D820	*	82	J, K	1.2±0.15
CMC 3216CG 3D101	*	100	J, K	1.2±0.15
CMC 3216CG 3D121	*	120	J, K	1.2±0.15
CMC 3216CG 3D151	*	150	J, K	1.2±0.15
CMC 3216CG 3D181	*	180	J, K	1.6±0.20
CMC 3216CG 3D221	*	220	J, K	1.6±0.20

MULTILAYER CERAMIC CAPACITORS

HIGH VOLTAGE CMC 4520 (1808) SERIES

Rated Voltage: 2KV

Part No.		Capacitance (PF)	Tolerance	Thickness (mm)
CMC 4520CG 3D101	*	100	J, K	1.2±0.15
CMC 4520CG 3D121	*	120	J, K	1.2±0.15
CMC 4520CG 3D151	*	150	J, K	1.2±0.15
CMC 4520CG 3D181	*	180	J, K	1.6±0.20
CMC 4520CG 3D221	*	220	J, K	1.6±0.20

Rated Voltage: 3KV

CMC 4520CG 3F2R0	*	2.0	C	1.2±0.15
CMC 4520 CG 3F3R6	*	3.6	C	1.2±0.15
CMC 4520 CG 3F5R0	*	5.0	C	1.2±0.15
CMC 4520CG 3F5R6	*	5.6	C	1.2±0.15
CMC 4520 CG 3F6R0	*	6.0	D	1.2±0.15
CMC 4520CG 3F6R8	*	6.8	D	1.2±0.15
CMC 4520CG 3F100	*	10	J, K	1.2±0.15
CMC 4520CG 3F120	*	12	J, K	1.2±0.15
CMC 4520CG 3F150	*	15	J, K	1.2±0.15
CMC 4520CG 3F180	*	18	J, K	1.2±0.15
CMC 4520CG 3F220	*	22	J, K	1.2±0.15
CMC 4520CG 3F270	*	27	J, K	1.2±0.15
CMC 4520CG 3F330	*	33	J, K	1.2±0.15
CMC 4520CG 3F390	*	39	J, K	1.2±0.15
CMC 4520CG 3F470	*	47	J, K	1.2±0.15
CMC 4520CG 3F560	*	56	J, K	1.2±0.15
CMC 4520CG 3F680	*	68	J, K	1.2±0.15
CMC 4520CG 3F820	*	82	J, K	1.2±0.15
CMC 4520CG 3F101	*	100	J, K	1.2±0.15
CMC 4520CG 3F121	*	120	J, K	1.2±0.15
CMC 4520CG 3F151	*	150	J, K	1.2±0.15

MULTILAYER CERAMIC CAPACITORS

MID VOLTAGE CMC 4532 (1812) SERIES

Rated Voltage: 100V

Part No.		Capacitance (PF)	Tolerance	Thickness (mm)
CMC 4532CG 2A102	*	1000	J, K	1.2±0.15
CMC 4532CG 2A122	*	1200	J, K	1.2±0.15
CMC 4532CG 2A152	*	1500	J, K	1.2±0.15
CMC 4532CG 2A182	*	1800	J, K	1.2±0.15
CMC 4532CG 2A222	*	2200	J, K	1.2±0.15
CMC 4532CG 2A272	*	2700	J, K	1.2±0.15
CMC 4532CG 2A332	*	3300	J, K	1.2±0.15
CMC 4532CG 2A392	*	3900	J, K	1.2±0.15
CMC 4532CG 2A472	*	4700	J, K	1.2±0.15
CMC 4532CG 2A562	*	5600	J, K	1.2±0.15
CMC 4532CG 2A682	*	6800	J, K	1.2±0.15
CMC 4532CG 2A822	*	8200	J, K	1.2±0.15
CMC 4532CG 2A103	*	10000	J, K	1.6±0.20
CMC 4532CG 2A123	*	12000	J, K	1.6±0.20

Rated Voltage: 250V

CMC 4532CG 2E102	*	1000	J, K	1.2±0.15
CMC 4532CG 2E122	*	1200	J, K	1.2±0.15
CMC 4532CG 2E152	*	1500	J, K	1.2±0.15
CMC 4532CG 2E182	*	1800	J, K	1.2±0.15
CMC 4532CG 2E222	*	2200	J, K	1.2±0.15
CMC 4532CG 2E272	*	2700	J, K	1.2±0.15
CMC 4532CG 2E332	*	3300	J, K	1.2±0.15
CMC 4532CG 2E392	*	3900	J, K	1.2±0.15
CMC 4532CG 2E472	*	4700	J, K	1.2±0.15
CMC 4532CG 2E562	*	5600	J, K	1.2±0.15
CMC 4532CG 2E682	*	6800	J, K	1.2±0.15
CMC 4532CG 2E822	*	8200	J, K	1.2±0.15
CMC 4532CG 2E103	*	10000	J, K	1.6±0.20

Rated Voltage: 500V

CMC 4532CG 2H102	*	1000	J, K	1.2±0.15
CMC 4532CG 2H122	*	1200	J, K	1.2±0.15
CMC 4532CG 2H152	*	1500	J, K	1.2±0.15
CMC 4532CG 2H182	*	1800	J, K	1.2±0.15
CMC 4532CG 2H222	*	2200	J, K	1.2±0.15
CMC 4532CG 2H272	*	2700	J, K	1.2±0.15
CMC 4532CG 2H332	*	3300	J, K	1.6±0.15
CMC 4532CG 2H392	*	3900	J, K	1.6±0.15
CMC 4532CG 2H472	*	4700	J, K	1.6±0.15

MULTILAYER CERAMIC CAPACITORS

HIGH VOLTAGE CMC 4532 (1812) SERIES

Rated Voltage: 1KV

Part No.		Capacitance (PF)	Tolerance	Thickness (mm)
CMC 4532CG 3A101	*	100	J, K	1.2±0.15
CMC 4532CG 3A121	*	120	J, K	1.2±0.15
CMC 4532CG 3A151	*	150	J, K	1.2±0.15
CMC 4532CG 3A181	*	180	J, K	1.2±0.15
CMC 4532CG 3A221	*	220	J, K	1.2±0.15
CMC 4532CG 3A271	*	270	J, K	1.2±0.15
CMC 4532CG 3A331	*	330	J, K	1.2±0.15
CMC 4532CG 3A391	*	390	J, K	1.2±0.15
CMC 4532CG 3A471	*	470	J, K	1.2±0.15
CMC 4532CG 3A561	*	560	J, K	1.2±0.15
CMC 4532CG 3A681	*	680	J, K	1.2±0.15
CMC 4532CG 3A821	*	820	J, K	1.2±0.15
CMC 4532CG 3A102	*	1000	J, K	1.2±0.15
CMC 4532CG 3A122	*	1200	J, K	1.2±0.15
CMC 4532CG 3A152	*	1500	J, K	1.2±0.15
CMC 4532CG 3A182	*	1800	J, K	1.2±0.15
CMC 4532CG 3A222	*	2200	J, K	1.2±0.15
CMC 4532CG 3A272	*	2700	J, K	1.2±0.15
CMC 4532CG 3A332	*	3300	J, K	1.6±0.20
CMC 4532CG 3A392	*	3900	J, K	1.6±0.20
CMC 4532CG 3A472	*	4700	J, K	2.0±0.20

Rated Voltage: 2KV

CMC 4532CG 3D101	*	100	J, K	1.2±0.15
CMC 4532CG 3D121	*	120	J, K	1.2±0.15
CMC 4532CG 3D151	*	150	J, K	1.2±0.15
CMC 4532CG 3D181	*	180	J, K	1.2±0.15
CMC 4532CG 3D221	*	220	J, K	1.2±0.15
CMC 4532CG 3D271	*	270	J, K	1.2±0.15
CMC 4532CG 3D331	*	330	J, K	1.2±0.15
CMC 4532CG 3D391	*	390	J, K	1.2±0.15
CMC 4532CG 3D471	*	470	J, K	1.2±0.15
CMC 4532CG 3D561	*	560	J, K	1.2±0.15
CMC 4532CG 3D681	*	680	J, K	1.2±0.15
CMC 4532CG 3D821	*	820	J, K	1.2±0.15
CMC 4532CG 3D102	*	1000	J, K	1.2±0.15

Rated Voltage: 3KV

CMC 4532CG 3F101	*	100	J, K	1.2±0.15
CMC 4532CG 3F121	*	120	J, K	1.2±0.15
CMC 4532CG 3F151	*	150	J, K	1.2±0.15
CMC 4532CG 3F181	*	180	J, K	1.2±0.15
CMC 4532CG 3F221	*	220	J, K	1.2±0.15
CMC 4532CG 3F271	*	270	J, K	1.2±0.15
CMC 4532CG 3F331	*	330	J, K	1.2±0.15
CMC 4532CG 3F391	*	390	J, K	1.2±0.15
CMC 4532CG 3F471	*	470	J, K	1.2±0.15

MULTILAYER CERAMIC CAPACITORS
MID VOLTAGE CMC 4532 (1812) SERIES
Rated Voltage: 100V

Part No.		Capacitance (PF)	Tolerance	Thickness (mm)
CMC 4532CG 2A102	*	1000	J, K	1.2±0.2
CMC 4532CG 2A222	*	2200	J, K	1.2±0.2
CMC 4532CG 2A272	*	2700	J, K	1.2±0.2
CMC 4532CG 2A332	*	3300	J, K	1.2±0.2
CMC 4532CG 2A392	*	3900	J, K	1.2±0.2
CMC 4532CG 2A472	*	4700	J, K	1.2±0.2
CMC 4532CG 2A562	*	5600	J, K	1.2±0.2
CMC 4532CG 2A682	*	6800	J, K	1.2±0.2
CMC 4532CG 2A822	*	8200	J, K	1.2±0.2
CMC 4532CG 2A103	*	10000	J, K	1.2±0.2
CMC 4532CG 2A123	*	12000	J, K	1.2±0.2
CMC 4532CG 2A153	*	15000	J, K	1.2±0.2
CMC 4532CG 2A183	*	18000	J, K	1.2±0.2
CMC 4532CG 2A223	*	22000	J, K	1.2±0.2

Rated Voltage: 250V

CMC 4532CG 2E102	*	1000	J, K	1.2±0.2
CMC 4532CG 2E122	*	1200	J, K	1.2±0.2
CMC 4532CG 2E152	*	1500	J, K	1.2±0.2
CMC 4532CG 2E182	*	1800	J, K	1.2±0.2
CMC 4532CG 2E222	*	2200	J, K	1.2±0.2
CMC 4532CG 2E272	*	2700	J, K	1.2±0.2
CMC 4532CG 2E332	*	3300	J, K	1.2±0.2
CMC 4532CG 2E392	*	3900	J, K	1.2±0.2
CMC 4532CG 2E472	*	4700	J, K	1.2±0.2
CMC 4532CG 2E562	*	5600	J, K	1.2±0.2
CMC 4532CG 2E682	*	6800	J, K	1.2±0.2
CMC 4532CG 2E822	*	8200	J, K	1.2±0.2
CMC 4532CG 2E103	*	10000	J, K	1.2±0.2

Rated Voltage: 500V

CMC 4532CG 2H102	*	1000	J, K	1.2±0.2
CMC 4532CG 2H122	*	1200	J, K	1.2±0.2
CMC 4532CG 2H152	*	1500	J, K	1.2±0.2
CMC 4532CG 2H182	*	1800	J, K	1.2±0.2
CMC 4532CG 2H222	*	2200	J, K	1.2±0.2
CMC 4532CG 2H272	*	2700	J, K	1.2±0.2
CMC 4532CG 2H332	*	3300	J, K	1.2±0.2
CMC 4532CG 2H392	*	3900	J, K	1.2±0.2
CMC 4532CG 2H472	*	4700	J, K	1.2±0.2

MULTILAYER CERAMIC CAPACITORS
HIGH VOLTAGE CMC 4532 (1812) SERIES

Rated Voltage: 1KV

Part No.		Capacitance (PF)	Tolerance	Thickness (mm)
CMC 4532CG 3A101	*	100	J, K	1.6±0.2
CMC 4532CG 3A121	*	120	J, K	1.6±0.2
CMC 4532CG 3A151	*	150	J, K	1.6±0.2
CMC 4532CG 3A181	*	180	J, K	1.6±0.2
CMC 4532CG 3A221	*	220	J, K	1.6±0.2
CMC 4532CG 3A271	*	270	J, K	1.6±0.2
CMC 4532CG 3A331	*	330	J, K	1.6±0.2
CMC 4532CG 3A391	*	390	J, K	1.6±0.2
CMC 4532CG 3A471	*	470	J, K	1.6±0.2
CMC 4532CG 3A561	*	560	J, K	1.6±0.2
CMC 4532CG 3A681	*	680	J, K	1.6±0.2
CMC 4532CG 3A821	*	820	J, K	1.6±0.2
CMC 4532CG 3A102	*	1000	J, K	1.6±0.2
CMC 4532CG 3A122	*	1200	J, K	1.6±0.2
CMC 4532CG 3A152	*	1500	J, K	1.6±0.2
CMC 4532CG 3A182	*	1800	J, K	1.6±0.2
CMC 4532CG 3A222	*	2200	J, K	1.6±0.2
CMC 4532CG 3A272	*	2700	J, K	1.6±0.2
CMC 4532CG 3A332	*	3300	J, K	1.6±0.2
CMC 4532CG 3A392	*	3900	J, K	1.6±0.2
CMC 4532CG 3A472	*	4700	J, K	2.0±0.2

Rated Voltage: 2KV

CMC 4532CG 3D101	*	100	J, K	1.6±0.2
CMC 4532CG 3D121	*	120	J, K	1.6±0.2
CMC 4532CG 3D151	*	150	J, K	1.6±0.2
CMC 4532CG 3D181	*	180	J, K	1.6±0.2
CMC 4532CG 3D221	*	220	J, K	1.6±0.2
CMC 4532CG 3D271	*	270	J, K	1.6±0.2
CMC 4532CG 3D331	*	330	J, K	1.6±0.2
CMC 4532CG 3D391	*	390	J, K	1.6±0.2
CMC 4532CG 3D471	*	470	J, K	1.6±0.2
CMC 4532CG 3D561	*	560	J, K	1.6±0.2
CMC 4532CG 3D681	*	680	J, K	1.6±0.2
CMC 4532CG 3D821	*	820	J, K	1.6±0.2
CMC 4532CG 3D102	*	1000	J, K	2.0±0.2

Rated Voltage: 3KV

CMC 4532CG 3F101	*	100	J, K	1.6±0.2
CMC 4532CG 3F121	*	120	J, K	1.6±0.2
CMC 4532CG 3F151	*	150	J, K	1.6±0.2
CMC 4532CG 3F181	*	180	J, K	1.6±0.2
CMC 4532CG 3F221	*	220	J, K	1.6±0.2
CMC 4532CG 3F271	*	270	J, K	1.6±0.2
CMC 4532CG 3F331	*	330	J, K	1.6±0.2
CMC 4532CG 3F391	*	390	J, K	1.6±0.2
CMC 4532CG 3F471	*	470	J, K	2.0±0.2

MULTILAYER CERAMIC CAPACITORS

MID VOLTAGE CMK 1608 (0603) SERIES

Rated Voltage: 100V

Part No.		Capacitance (PF)	Tolerance	Thickness (mm)
CMK 1608XR 2A221	*	220	K, M	0.8±0.10
CMK 1608XR 2A271	*	270	K, M	0.8±0.10
CMK 1608XR 2A331	*	330	K, M	0.8±0.10
CMK 1608XR 2A391	*	390	K, M	0.8±0.10
CMK 1608XR 2A471	*	470	K, M	0.8±0.10
CMK 1608XR 2A561	*	560	K, M	0.8±0.10
CMK 1608XR 2A681	*	680	K, M	0.8±0.10
CMK 1608XR 2A821	*	820	K, M	0.8±0.10
CMK 1608XR 2A102	*	1000	K, M	0.8±0.10
CMK 1608XR 2A122	*	1200	K, M	0.8±0.10
CMK 1608XR 2A152	*	1500	K, M	0.8±0.10
CMK 1608XR 2A182	*	1800	K, M	0.8±0.10
CMK 1608XR 2A222	*	2200	K, M	0.8±0.10
CMK 1608XR 2A272	*	2700	K, M	0.8±0.10
CMK 1608XR 2A332	*	3300	K, M	0.8±0.10
CMK 1608XR 2A392	*	3900	K, M	0.8±0.10
CMK 1608XR 2A472	*	4700	K, M	0.8±0.10
CMK 1608XR 2A562	*	5600	K, M	0.8±0.10
CMK 1608XR 2A682	*	6800	K, M	0.8±0.10
CMK 1608XR 2A822	*	8200	K, M	0.8±0.10
CMK 1608XR 2A103	*	10000	K, M	0.8±0.10

Rated Voltage: 250V

CMK 1608XR 2E221	*	220	K, M	0.8±0.10
CMK 1608XR 2E271	*	270	K, M	0.8±0.10
CMK 1608XR 2E331	*	330	K, M	0.8±0.10
CMK 1608XR 2E391	*	390	K, M	0.8±0.10
CMK 1608XR 2E471	*	470	K, M	0.8±0.10
CMK 1608XR 2E561	*	560	K, M	0.8±0.10
CMK 1608XR 2E681	*	680	K, M	0.8±0.10
CMK 1608XR 2E820	*	820	K, M	0.8±0.10
CMK 1608XR 2E102	*	1000	K, M	0.8±0.10
CMK 1608XR 2E122	*	1200	K, M	0.8±0.10
CMK 1608XR 2E152	*	1500	K, M	0.8±0.10
CMK 1608XR 2E182	*	1800	K, M	0.8±0.10
CMK 1608XR 2E222	*	2200	K, M	0.8±0.10
CMK 1608XR 2E272	*	2700	K, M	0.8±0.10
CMK 1608XR 2E332	*	3300	K, M	0.8±0.10
CMK 1608XR 2E392	*	3900	K, M	0.8±0.10
CMK 1608XR 2E472	*	4700	K, M	0.8±0.10

MULTILAYER CERAMIC CAPACITORS

MID VOLTAGE CMK 2012 (0805) SERIES

Rated Voltage: 100V

Part No.		Capacitance (PF)	Tolerance	Thickness (mm)
CMK 2012XR 2A221	*	220	K, M	0.6±0.10
CMK 2012XR 2A271	*	270	K, M	0.6±0.10
CMK 2012XR 2A331	*	330	K, M	0.8±0.10
CMK 2012XR 2A391	*	390	K, M	0.8±0.10
CMK 2012XR 2A471	*	470	K, M	0.8±0.10
CMK 2012XR 2A561	*	560	K, M	0.8±0.10
CMK 2012XR 2A681	*	680	K, M	0.8±0.10
CMK 2012XR 2A821	*	820	K, M	0.8±0.10
CMK 2012XR 2A102	*	1000	K, M	0.8±0.10
CMK 2012XR 2A122	*	1200	K, M	0.8±0.10
CMK 2012XR 2A152	*	1500	K, M	0.8±0.10
CMK 2012XR 2A182	*	1800	K, M	0.8±0.10
CMK 2012XR 2A222	*	2200	K, M	0.8±0.10
CMK 2012XR 2A272	*	2700	K, M	0.8±0.10
CMK 2012XR 2A332	*	3300	K, M	0.8±0.10
CMK 2012XR 2A392	*	3900	K, M	0.8±0.10
CMK 2012XR 2A472	*	4700	K, M	0.8±0.10
CMK 2012XR 2A562	*	5600	K, M	1.0±0.15
CMK 2012XR 2A682	*	6800	K, M	1.0±0.15
CMK 2012XR 2A822	*	8200	K, M	0.8±0.10
CMK 2012XR 2A103	*	10000	K, M	0.8±0.10
CMK 2012XR 2A123	*	12000	K, M	0.8±0.10
CMK 2012XR 2A153	*	15000	K, M	0.8±0.10
CMK 2012XR 2A183	*	18000	K, M	0.8±0.10
CMK 2012XR 2A223	*	22000	K, M	1.0±0.15
CMK 2012XR 2A273	*	27000	K, M	1.0±0.15
CMK 2012XR 2A333	*	33000	K, M	1.2±0.15
CMK 2012XR 2A473	*	47000	K, M	1.2±0.15

Rated Voltage: 250V

CMK 2012XR 2E221	*	220	K, M	0.6±0.10
CMK 2012XR 2E271	*	270	K, M	0.6±0.10
CMK 2012XR 2E331	*	330	K, M	0.8±0.10
CMK 2012XR 2E391	*	390	K, M	0.8±0.10
CMK 2012XR 2E471	*	470	K, M	0.8±0.10
CMK 2012XR 2E561	*	560	K, M	0.8±0.10
CMK 2012XR 2E681	*	680	K, M	0.8±0.10
CMK 2012XR 2E821	*	820	K, M	0.8±0.10
CMK 2012XR 2E102	*	1000	K, M	0.8±0.10
CMK 2012XR 2E122	*	1200	K, M	0.8±0.10
CMK 2012XR 2E152	*	1500	K, M	0.8±0.10
CMK 2012XR 2E182	*	1800	K, M	0.8±0.10
CMK 2012XR 2E222	*	2200	K, M	0.8±0.10
CMK 2012XR 2E272	*	2700	K, M	0.8±0.10
CMK 2012XR 2E332	*	3300	K, M	0.8±0.10

MULTILAYER CERAMIC CAPACITORS

MID VOLTAGE CMK 2012 (0805) SERIES

Rated Voltage: 250V

Part No.		Capacitance (PF)	Tolerance	Thickness (mm)
CMK 2012XR 2E392	*	3900	K, M	0.8±0.10
CMK 2012XR 2E472	*	4700	K, M	0.8±0.10
CMK 2012XR 2E562	*	5600	K, M	0.8±0.10
CMK 2012XR 2E682	*	6800	K, M	0.8±0.10
CMK 2012XR 2E822	*	8200	K, M	0.8±0.10
CMK 2012XR 2E103	*	10000	K, M	0.8±0.10
CMK 2012XR 2E123	*	1200	K, M	0.8±0.10
CMK 2012XR 2E153	*	15000	K, M	0.8±0.10
CMK 2012XR 2E183	*	18000	K, M	0.8±0.10
CMK 2012XR 2E223	*	22000	K, M	1.0±0.15

Rated Voltage: 500V

CMK 2012CG 2H221	*	220	K, M	0.6±0.10
CMK 2012CG 2H271	*	270	K, M	0.6±0.10
CMK 2012CG 2H331	*	330	K, M	0.8±0.10
CMK 2012CG 2H391	*	390	K, M	0.8±0.10
CMK 2012CG 2H471	*	470	K, M	0.8±0.10
CMK 2012CG 2H561	*	560	K, M	0.8±0.10
CMK 2012CG 2H681	*	680	K, M	0.8±0.10
CMK 2012CG 2H821	*	820	K, M	0.8±0.10
CMK 2012CG 2H102	*	1000	K, M	0.8±0.10
CMK 2012CG 2H122	*	1200	K, M	0.8±0.10
CMK 2012CG 2H152	*	1500	K, M	1.0±0.15
CMK 2012CG 2H182	*	1800	K, M	1.0±0.15
CMK 2012CG 2H222	*	2200	K, M	1.2±0.15
CMK 2012CG 2H272	*	2700	K, M	1.2±0.15
CMK 2012CG 2H332	*	3300	K, M	1.2±0.15
CMK 2012CG 2H392	*	3900	K, M	1.2±0.15
CMK 2012CG 2H472	*	4700	K, M	1.2±0.15

Rated Voltage: 1KV

CMK 2012CG 3A221	*	220	K, M	0.8±0.10
CMK 2012CG 3A271	*	270	K, M	0.8±0.10
CMK 2012CG 3A331	*	330	K, M	0.8±0.10
CMK 2012CG 3A391	*	390	K, M	1.0±0.15
CMK 2012CG 3A471	*	470	K, M	1.0±0.15
CMK 2012CG 3A561	*	560	K, M	1.2±0.15
CMK 2012CG 3A681	*	680	K, M	1.2±0.15
CMK 2012CG 3A821	*	820	K, M	1.2±0.15
CMK 2012CG 3A102	*	1000	K, M	1.2±0.15
CMK 2012CG 3A122	*	1200	K, M	1.2±0.15
CMK 2012CG 3A152	*	1500	K, M	1.2±0.15

MULTILAYER CERAMIC CAPACITORS

MID VOLTAGE CMK 3216 (1206) SERIES

Rated Voltage: 100V

Part No.		Capacitance (PF)	Tolerance	Thickness (mm)
CMK 3216XR 2A333	*	33000	K,M	0.8±0.10
CMK 3216XR 2A473	*	47000	K,M	0.8±0.10
CMK 3216XR 2A563	*	56000	K,M	0.8±0.10
CMK 3216XR 2A683	*	68000	K,M	0.8±0.10
CMK 3216XR 2A823	*	82000	K,M	0.8±0.10
CMK 3216XR 2A104	*	100000	K,M	0.8±0.10

Rated Voltage: 250V

CMK 3216XR 2E103	*	10000	K,M	0.8±0.10
CMK 3216XR 2E123	*	12000	K,M	0.8±0.10
CMK 3216XR 2E153	*	15000	K,M	0.8±0.10
CMK 3216XR 2E183	*	18000	K,M	0.8±0.10
CMK 3216XR 2E223	*	22000	K,M	0.8±0.10
CMK 3216XR 2E333	*	33000	K,M	0.8±0.10
CMK 3216XR 2E393	*	39000	K,M	0.8±0.10
CMK 3216XR 2E473	*	47000	K,M	0.8±0.10

Rated Voltage: 500V

CMK 3216XR 2H221	*	220	K,M	0.8±0.10
CMK 3216XR 2H271	*	270	K,M	0.8±0.10
CMK 3216XR 2H331	*	330	K,M	0.8±0.10
CMK 3216XR 2H391	*	390	K,M	0.8±0.10
CMK 3216XR 2H471	*	470	K,M	0.8±0.10
CMK 3216XR 2H561	*	560	K,M	0.8±0.10
CMK 3216XR 2H681	*	680	K,M	0.8±0.10
CMK 3216XR 2H821	*	820	K,M	0.8±0.10
CMK 3216XR 2H102	*	1000	K,M	0.8±0.10
CMK 3216XR 2H122	*	1200	K,M	0.8±0.10
CMK 3216XR 2H152	*	1500	K,M	0.8±0.10
CMK 3216XR 2H182	*	1800	K,M	0.8±0.10
CMK 3216XR 2H222	*	2200	K,M	0.8±0.10
CMK 3216XR 2H272	*	2700	K,M	0.8±0.10
CMK 3216XR 2H332	*	3300	K,M	1.0±0.15
CMK 3216XR 2H392	*	3900	K,M	1.0±0.15
CMK 3216XR 2H472	*	4700	K,M	1.0±0.15
CMK 3216XR 2H562	*	5600	K,M	1.2±0.15
CMK 3216XR 2H682	*	6800	K,M	1.2±0.15
CMK 3216XR 2H822	*	8200	K,M	1.2±0.15
CMK 3216XR 2H103	*	10000	K,M	1.6±0.20
CMK 3216XR 2H123	*	12000	K,M	1.6±0.20
CMK 3216XR 2H153	*	15000	K,M	1.6±0.20
CMK 3216XR 2H183	*	18000	K,M	1.6±0.20
CMK 3216XR 2H223	*	22000	K,M	1.6±0.20

MULTILAYER CERAMIC CAPACITORS

HIGH VOLTAGE CMK 3216 (1206) SERIES

Rated Voltage: 1KV

Part No.		Capacitance (PF)	Tolerance	Thickness (mm)
CMK 3216XR 3A101	*	100	K,M	0.8±0.10
CMK 3216XR 3A221	*	220	K,M	0.8±0.10
CMK 3216XR 3A271	*	270	K,M	0.8±0.10
CMK 3216XR 3A331	*	330	K,M	0.8±0.10
CMK 3216XR 3A391	*	390	K,M	0.8±0.10
CMK 3216XR 3A471	*	470	K,M	0.8±0.10
CMK 3216XR 3A561	*	560	K,M	0.8±0.10
CMK 3216XR 3A681	*	680	K,M	0.8±0.10
CMK 3216XR 3A821	*	820	K,M	0.8±0.10
CMK 3216XR 3A102	*	1000	K,M	0.8±0.10
CMK 3216XR 3A122	*	1200	K,M	0.8±0.10
CMK 3216XR 3A152	*	1500	K,M	1.2±0.15
CMK 3216XR 3A182	*	1800	K,M	1.2±0.15
CMK 3216XR 3A222	*	2200	K,M	1.2±0.15
CMK 3216XR 3A272	*	2700	K,M	1.2±0.15
CMK 3216XR 3A332	*	3300	K,M	1.2±0.15
CMK 3216XR 3A392	*	3900	K,M	1.2±0.15
CMK 3216XR 3A472	*	4700	K,M	1.2±0.15
CMK 3216XR 3A562	*	5600	K,M	1.2±0.15
CMK 3216XR 3A682	*	6800	K,M	1.2±0.15
CMK 3216XR 3A822	*	8200	K,M	1.2±0.15
CMK 3216XR 3A103	*	10000	K,M	1.2±0.15

Rated Voltage: 2KV

CMK 3216XR 3D221	*	220	K,M	1.2±0.15
CMK 3216XR 3D271	*	270	K,M	1.2±0.15
CMK 3216XR 3D331	*	330	K,M	1.2±0.15
CMK 3216XR 3D391	*	390	K,M	1.2±0.15
CMK 3216XR 3D471	*	470	K,M	1.2±0.15
CMK 3216XR 3D561	*	560	K,M	1.2±0.15
CMK 3216XR 3D681	*	680	K,M	1.2±0.15
CMK 3216XR 3D821	*	820	K,M	1.2±0.15
CMK 3216XR 3D102	*	1000	K,M	1.2±0.15
CMK 3216XR 3D122	*	1200	K,M	1.2±0.15
CMK 3216XR 3D152	*	1500	K,M	1.2±0.15
CMK 3216XR 3D182	*	1800	K,M	1.6±0.20
CMK 3216XR 3D222	*	2200	K,M	1.6±0.20

MULTILAYER CERAMIC CAPACITORS

MID VOLTAGE CMK 3225 (1210) SERIES

Rated Voltage: 100V

Part No.		Capacitance (PF)	Tolerance	Thickness (mm)
CMK 3225XR 2A104	*	100000	K,M	0.8±0.10
CMK 3225XR 2A124	*	120000	K,M	1.0±0.15
CMK 3225XR 2A154	*	150000	K,M	1.0±0.15
CMK 3225XR 2A182	*	180000	K,M	1.2±0.15
CMK 3225XR 2A224	*	220000	K,M	1.2±0.15

Rated Voltage: 250V

CMK 3225XR 2E683	*	68000	K,M	0.8±0.10
CMK 3225XR 2E823	*	82000	K,M	0.8±0.10
CMK 3225XR 2E104	*	100000	K,M	0.8±0.10
CMK 3225XR 2E124	*	120000	K,M	1.0±0.15
CMK 3225XR 2E154	*	150000	K,M	1.0±0.15
CMK 3225XR 2E224	*	220000	K,M	1.2±0.15

Rated Voltage: 500V

CMK 3225XR 2H223	*	22000	K,M	1.2±0.15
CMK 3225XR 2H273	*	27000	K,M	1.2±0.15
CMK 3225XR 2H333	*	33000	K,M	1.6±0.20
CMK 3225XR 2H393	*	39000	K,M	1.6±0.20
CMK 3225XR 2H473	*	47000	K,M	2.0±0.20

MULTILAYER CERAMIC CAPACITORS**HIGH VOLTAGE CMK 3225 (1210) SERIES****Rated Voltage: 1KV**

Part No.		Capacitance (PF)	Tolerance	Thickness (mm)
CMK 3225XR 3A103	*	10000	K,M	1.2±0.15
CMK 3225XR 3A123	*	12000	K,M	1.2±0.15
CMK 3225XR 3A153	*	15000	K,M	1.2±0.15
CMK 3225XR 3A183	*	18000	K,M	1.2±0.15
CMK 3225XR 3A223	*	22000	K,M	1.2±0.15

Rated Voltage: 2KV

CMK 3225XR 3D272	*	2700	K,M	1.2±0.15
CMK 3225XR 3D332	*	3300	K,M	1.2±0.15
CMK 3225XR 3D392	*	3900	K,M	1.2±0.15
CMK 3225XR 3D472	*	4700	K,M	1.2±0.15

MULTILAYER CERAMIC CAPACITORS

HIGH VOLTAGE CMK 4520 (1808) SERIES

Rated Voltage: 1KV

Part No.		Capacitance (PF)	Tolerance	Thickness (mm)
CMK 4520XR 3A221	*	220	K,M	1.2±0.15
CMK 4520XR 3A271	*	270	K,M	1.2±0.15
CMK 4520XR 3A331	*	330	K,M	1.2±0.15
CMK 4520XR 3A391	*	390	K,M	1.2±0.15
CMK 4520XR 3A471	*	470	K,M	1.2±0.15
CMK 4520XR 3A561	*	560	K,M	1.2±0.15
CMK 4520XR 3A681	*	680	K,M	1.2±0.15
CMK 4520XR 3A821	*	820	K,M	1.2±0.15
CMK 4520XR 3A102	*	1000	K,M	1.2±0.15
CMK 4520XR 3A122	*	1200	K,M	1.2±0.15
CMK 4520XR 3A152	*	1500	K,M	1.2±0.15
CMK 4520XR 3A182	*	1800	K,M	1.2±0.15
CMK 4520XR 3A222	*	2200	K,M	1.2±0.15
CMK 4520XR 3A272	*	2700	K,M	1.2±0.15
CMK 4520XR 3A332	*	3300	K,M	1.2±0.15
CMK 4520XR 3A392	*	3900	K,M	1.2±0.15
CMK 4520XR 3A472	*	4700	K,M	1.2±0.15
CMK 4520XR 3A562	*	5600	K,M	1.2±0.15
CMK 4520XR 3A682	*	6800	K,M	1.2±0.15
CMK 4520XR 3A822	*	8200	K,M	1.6±0.20
CMK 4520XR 3A103	*	10000	K,M	1.6±0.20
CMK 4520XR 3A123	*	12000	K,M	1.6±0.20
CMK 4520XR 3A153	*	15000	K,M	1.6±0.20
CMK 4520XR 3A183	*	18000	K,M	1.6±0.20

MULTILAYER CERAMIC CAPACITORS

HIGH VOLTAGE CMK 4520 (1808) SERIES

Rated Voltage: 2KV

Part No.		Capacitance (PF)	Tolerance	Thickness (mm)
CMK 4520XR 3D221	*	220	K,M	1.2±0.15
CMK 4520XR 3D271	*	270	K,M	1.2±0.15
CMK 4520XR 3D331	*	330	K,M	1.2±0.15
CMK 4520XR 3D391	*	390	K,M	1.2±0.15
CMK 4520XR 3D471	*	470	K,M	1.2±0.15
CMK 4520XR 3D561	*	560	K,M	1.2±0.15
CMK 4520XR 3D681	*	680	K,M	1.2±0.15
CMK 4520XR 3D821	*	820	K,M	1.2±0.15
CMK 4520XR 3D102	*	1000	K,M	1.2±0.15
CMK 4520XR 3D122	*	1200	K,M	1.2±0.15
CMK 4520XR 3D152	*	1500	K,M	1.2±0.15
CMK 4520XR 3D182	*	1800	K,M	1.2±0.15
CMK 4520XR 3D222	*	2200	K,M	1.2±0.15
CMK 4520XR 3D272	*	2700	K,M	1.2±0.15
CMK 4520XR 3D332	*	3300	K,M	1.2±0.15

Rated Voltage: 3KV

CMC 4520XR 3F221	*	220	K,M	1.6±0.20
CMC 4520XR 3F271	*	270	K,M	1.6±0.20
CMC 4520XR 3F331	*	330	K,M	1.6±0.20
CMC 4520XR 3F391	*	390	K,M	1.6±0.20
CMC 4520XR 3F471	*	470	K,M	1.6±0.20
CMC 4520XR 3F561	*	560	K,M	1.6±0.20
CMC 4520XR 3F681	*	680	K,M	1.6±0.20
CMC 4520XR 3F821	*	820	K,M	1.6±0.20
CMC 4520XR 3F102	*	1000	K,M	1.6±0.20

MULTILAYER CERAMIC CAPACITORS

MID VOLTAGE CMK 4532 (1812) SERIES

Rated Voltage: 100V

Part No.		Capacitance (PF)	Tolerance	Thickness (mm)
CMK 4532XR 2A104	*	100000	K,M	1.2±0.15
CMK 4532XR 2A124	*	120000	K,M	1.2±0.15
CMK 4532XR 2A154	*	150000	K,M	1.2±0.15
CMK 4532XR 2A224	*	220000	K,M	1.2±0.15
CMK 4532XR 2A274	*	270000	K,M	1.2±0.15
CMK 4532XR 2A334	*	330000	K,M	1.2±0.15
CMK 4532XR 2A394	*	390000	K,M	1.2±0.15
CMK 4532XR 2A474	*	470000	K,M	1.2±0.15
CMK 4532XR 2A684	*	680000	K,M	1.6±0.20

Rated Voltage: 250V

CMK 4532XR 2E473	*	47000	K,M	1.2±0.15
CMK 4532XR 2E563	*	56000	K,M	1.2±0.15
CMK 4532XR 2E683	*	68000	K,M	1.2±0.15
CMK 4532XR 2E823	*	82000	K,M	1.2±0.15
CMK 4532XR 2E104	*	100000	K,M	1.2±0.15
CMK 4532XR 2E124	*	120000	K,M	1.2±0.15
CMK 4532XR 2E154	*	150000	K,M	1.6±0.20
CMK 4532XR 2E224	*	220000	K,M	1.6±0.20
CMK 4532XR 2E334	*	330000	K,M	1.6±0.20

Rated Voltage: 500V

CMK 4532XR 2H472	*	4700	K,M	1.2±0.15
CMK 4532XR 2H562	*	5600	K,M	1.2±0.15
CMK 4532XR 2H682	*	6800	K,M	1.2±0.15
CMK 4532XR 2H822	*	8200	K,M	1.2±0.15
CMK 4532XR 2H103	*	10000	K,M	1.2±0.15
CMK 4532XR 2H123	*	12000	K,M	1.2±0.15
CMK 4532XR 2H153	*	15000	K,M	1.2±0.15
CMK 4532XR 2H183	*	18000	K,M	1.2±0.15
CMK 4532XR 2H223	*	22000	K,M	1.2±0.15
CMK 4532XR 2H273	*	27000	K,M	1.2±0.15
CMK 4532XR 2H333	*	33000	K,M	1.6±0.20
CMK 4532XR 2H393	*	39000	K,M	1.6±0.20
CMK 4532XR 2H473	*	47000	K,M	1.6±0.20
CMK 4532XR 2H563	*	56000	K,M	1.6±0.20
CMK 4532XR 2H683	*	68000	K,M	1.6±0.20
CMK 4532XR 2H823	*	82000	K,M	1.6±0.20

MULTILAYER CERAMIC CAPACITORS

HIGH VOLTAGE CMK 4532 (1812) SERIES

Rated Voltage: 1KV

Part No.		Capacitance (PF)	Tolerance	Thickness (mm)
CMK 4532XR 3A101	*	100	K,M	1.2±0.15
CMK 4532XR 3A121	*	120	K,M	1.2±0.15
CMK 4532XR 3A151	*	150	K,M	1.2±0.15
CMK 4532XR 3A181	*	180	K,M	1.2±0.15
CMK 4532XR 3A221	*	220	K,M	1.2±0.15
CMK 4532XR 3A271	*	270	K,M	1.2±0.15
CMK 4532XR 3A331	*	330	K,M	1.2±0.15
CMK 4532XR 3A391	*	390	K,M	1.2±0.15
CMK 4532XR 3A471	*	470	K,M	1.2±0.15
CMK 4532XR 3A561	*	560	K,M	1.2±0.15
CMK 4532XR 3A681	*	680	K,M	1.2±0.15
CMK 4532XR 3A821	*	820	K,M	1.2±0.15
CMK 4532XR 3A102	*	1000	K,M	1.2±0.15
CMK 4532XR 3A122	*	1200	K,M	1.2±0.15
CMK 4532XR 3A152	*	1500	K,M	1.2±0.15
CMK 4532XR 3A182	*	1800	K,M	1.2±0.15
CMK 4532XR 3A222	*	2200	K,M	1.2±0.15
CMK 4532XR 3A272	*	2700	K,M	1.2±0.15
CMK 4532XR 3A332	*	3300	K,M	1.2±0.15
CMK 4532XR 3A392	*	3900	K,M	1.2±0.15
CMK 4532XR 3A472	*	4700	K,M	1.2±0.15
CMK 4532XR 3A562	*	5600	K,M	1.2±0.15
CMK 4532XR 3A682	*	6800	K,M	1.2±0.15
CMK 4532XR 3A822	*	8200	K,M	1.2±0.15
CMK 4532XR 3A103	*	10000	K,M	1.2±0.15
CMK 4532XR 3A123	*	12000	K,M	1.2±0.15
CMK 4532XR 3A153	*	15000	K,M	1.6±0.20
CMK 4532XR 3A183	*	18000	K,M	1.6±0.20
CMK 4532XR 3A223	*	22000	K,M	1.6±0.20

MULTILAYER CERAMIC CAPACITORS

HIGH VOLTAGE CMK 4532 (1812) SERIES

Rated Voltage: 2KV

Part No.		Capacitance (PF)	Tolerance	Thickness (mm)
CMK 4532XR 3D101	*	100	K,M	1.2±0.15
CMK 4532XR 3D121	*	120	K,M	1.2±0.15
CMK 4532XR 3D151	*	150	K,M	1.2±0.15
CMK 4532XR 3D181	*	180	K,M	1.2±0.15
CMK 4532XR 3D221	*	220	K,M	1.2±0.15
CMK 4532XR 3D271	*	270	K,M	1.2±0.15
CMK 4532XR 3D331	*	330	K,M	1.2±0.15
CMK 4532XR 3D391	*	390	K,M	1.2±0.15
CMK 4532XR 3D471	*	470	K,M	1.2±0.15
CMK 4532XR 3D561	*	560	K,M	1.2±0.15
CMK 4532XR 3D681	*	680	K,M	1.2±0.15
CMK 4532XR 3D821	*	820	K,M	1.2±0.15
CMK 4532XR 3D102	*	1000	K,M	1.2±0.15
CMK 4532XR 3D122	*	1200	K,M	1.2±0.15
CMK 4532XR 3D152	*	1500	K,M	1.2±0.15
CMK 4532XR 3D182	*	1800	K,M	1.2±0.15
CMK 4532XR 3D222	*	2200	K,M	1.2±0.15
CMK 4532XR 3D272	*	2700	K,M	1.2±0.15
CMK 4532XR 3D332	*	3300	K,M	1.2±0.15
CMK 4532XR 3D392	*	3900	K,M	1.2±0.15
CMK 4532XR 3D472	*	4700	K,M	1.2±0.15

Rated Voltage: 3KV

CMK 4532XR 3F101	*	100	K,M	1.6±0.20
CMK 4532XR 3F121	*	120	K,M	1.6±0.20
CMK 4532XR 3F151	*	150	K,M	1.6±0.20
CMK 4532XR 3F181	*	180	K,M	1.6±0.20
CMK 4532XR 3F221	*	220	K,M	1.6±0.20
CMK 4532XR 3F271	*	270	K,M	1.6±0.20
CMK 4532XR 3F331	*	330	K,M	1.6±0.20
CMK 4532XR 3F391	*	390	K,M	1.6±0.20
CMK 4532XR 3F471	*	470	K,M	1.6±0.20
CMK 4532XR 3F561	*	560	K,M	1.6±0.20
CMK 4532XR 3F681	*	680	K,M	1.6±0.20
CMK 4532XR 3F821	*	820	K,M	1.6±0.20
CMK 4532XR 3F102	*	1000	K,M	1.6±0.20
CMK 4532XR 3F152	*	1500	K,M	1.6±0.20
CMK 4532XR 3F182	*	1800	K,M	1.6±0.20
CMK 4532XR 3F222	*	2200	K,M	1.6±0.20

MULTILAYER CERAMIC CAPACITORS**HIGH VOLTAGE CMK 5628 (2211) SERIES****Rated Voltage: 3KV**

Part No.		Capacitance (PF)	Tolerance	Thickness (mm)
CMK 5628XR 3F221	*	220	K,M	2.0±0.20
CMK 5628XR 3F271	*	270	K,M	2.0±0.20
CMK 5628XR 3F331	*	330	K,M	2.0±0.20
CMK 5628XR 3F391	*	390	K,M	2.0±0.20
CMK 5628XR 3F471	*	470	K,M	2.0±0.20
CMK 5628XR 3F561	*	560	K,M	2.0±0.20
CMK 5628XR 3F681	*	680	K,M	2.0±0.20
CMK 5628XR 3F821	*	820	K,M	2.0±0.20
CMK 5628XR 3F102	*	1000	K,M	2.0±0.20
CMK 5628XR 3F122	*	1200	K,M	2.0±0.20
CMK 5628XR 3F152	*	1500	K,M	2.0±0.20
CMK 5628XR 3F182	*	1800	K,M	2.0±0.20
CMK 5628XR 3F222	*	2200	K,M	2.0±0.20
CMK 5628XR 3F272	*	2700	K,M	2.0±0.20

PACKING INFORMATION

Standard Packing Quantity

Chip Size	Thickness(mm)	Max Carrier Depth (In 7" Reel)	Quantity of Cardboard Tape (In 7" Reel)	Quantity of Embossed Tape
1608(0603)	0.80 ± 0.10	0.95 mm	4000	-
2012(0805)	0.60 ± 0.10	0.75 mm	4000	-
	0.80 ± 0.10	0.90 mm	4000	-
	1.00 ± 0.15	1.00 mm	4000	-
	1.20 ± 0.15	1.20 mm	4000	-
3216(1206)	0.60 ± 0.10	0.85 mm	-	4000
	0.80 ± 0.10	1.04 mm	-	4000
	1.00 ± 0.15	1.25 mm	-	3000
	1.20 ± 0.15	1.45 mm	-	3000
	1.60 ± 0.20	1.85 mm	-	2000
3225(1210)	0.80 ± 0.10	1.07 mm	-	3000
	1.00 ± 0.15	1.20 mm	-	3000
	1.20 ± 0.15	1.55 mm	-	3001
	1.60 ± 0.20	1.74 mm	-	2000
4520(1808)	1.20 ± 0.15	1.45 mm	-	2000
	1.60 ± 0.20	1.85 mm	-	2000
4532(1812)	1.20 ± 0.15	1.40 mm	-	1000
	1.60 ± 0.20	1.85 mm	-	1000
	2.00 ± 0.20	2.15 mm	-	1000
5628(2211)	2.00 ± 0.20	2.20 mm	-	500

Reel For Taping

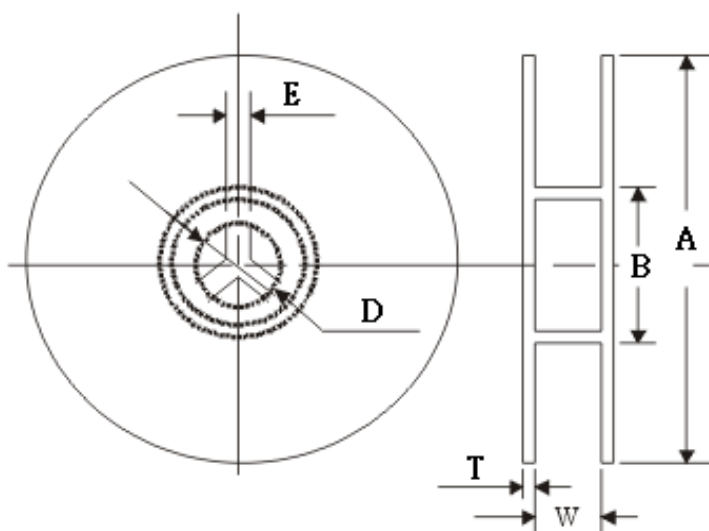

Dimension(mm)

Tape Width	2	B	C	D	E	W	T
8	178±2.0	50min	13.0±0.2	20min	1.5min	10.0±1.5	0.8±0.2
12	329±2.0	50min	13.0±0.2	20min	1.5min	13.5±1.5	2.5±0.5
8	329±2.0	50min	13.0±0.2	20min	1.5min	17.5±1.5	2.5±0.5

